

## 100MHz 100mA $V_{COM}$ Amplifiers

The EL9211, EL9212, and EL9214 feature 1, 2, and 4 channel high power output amplifiers. They are designed primarily for generation of  $V_{COM}$  voltages in TFT-LCD applications. Each amplifier features a -3dB bandwidth of 130MHz with slew rates of 115V/ $\mu$ s. Each device comes in a thermal package and can drive 300mA peak per output.

All units are available in Pb-free packaging only and are specified for operation over the -40°C to +85°C temperature range.

## Ordering Information

PART NUMBER (Note)	PART MARKING	PACKAGE (Pb-Free)	PKG. DWG. #
EL9211IWZ-T7*	BAAD	5 Ld SOT-23 Tape and Reel	MDP0038
EL9211IWZ-T7A*	BAAD	5 Ld SOT-23 Tape and Reel	MDP0038
EL9211IYEZ	BBBAA	8 Ld HMSOP	MDP0050
EL9211IYEZ-T7*	BBBAA	8 Ld HMSOP Tape and Reel	MDP0050
EL9211IYEZ-T13*	BBBAA	8 Ld HMSOP Tape and Reel	MDP0050
EL9212IYEZ	BBCAA	8 Ld HMSOP	MDP0050
EL9212IYEZ-T7*	BBCAA	8 Ld HMSOP Tape and Reel	MDP0050
EL9212IYEZ-T13*	BBCAA	8 Ld HMSOP Tape and Reel	MDP0050
EL9214IREZ	9214IRE Z	14 Ld HTSSOP	MDP0048
EL9214IREZ-T7*	9214IRE Z	14 Ld HTSSOP Tape and Reel	MDP0048
EL9214IREZ-T13*	9214IRE Z	14 Ld HTSSOP Tape and Reel	MDP0048

\*Please refer to TB347 for details on reel specifications.

NOTE: These Intersil Pb-free plastic packaged products employ special Pb-free material sets; molding compounds/die attach materials and 100% matte tin plate PLUS ANNEAL - e3 termination finish, which is RoHS compliant and compatible with both SnPb and Pb-free soldering operations. Intersil Pb-free products are MSL classified at Pb-free peak reflow temperatures that meet or exceed the Pb-free requirements of IPC/JEDEC J STD-020.

## Features

- 1, 2, and 4 channel versions
- 130MHz -3dB bandwidth
- 115V/ $\mu$ s slew rate
- 300mA peak output current
- Supply voltage from 5V to 13.5V
- Low supply current - <2.4mA per channel
- Pb-free available (RoHS compliant)

## Applications

- TFT-LCD  $V_{COM}$  supply
- Electronics notebooks
- Computer monitors
- Electronics games
- Touch-screen displays
- Portable instrumentation

## Pinouts

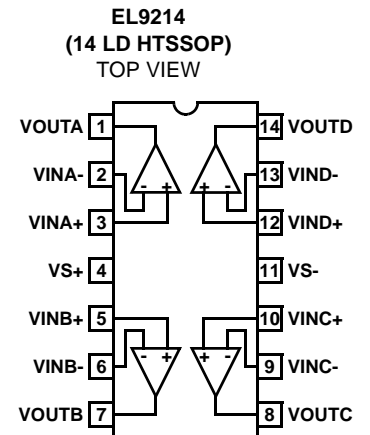
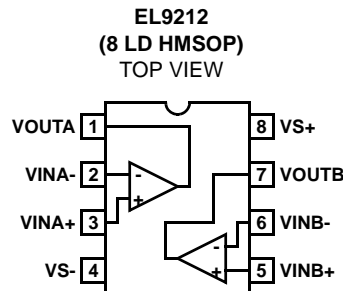
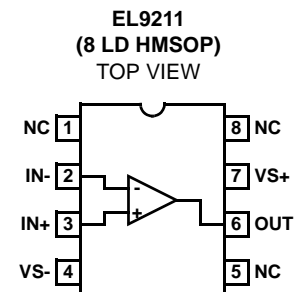
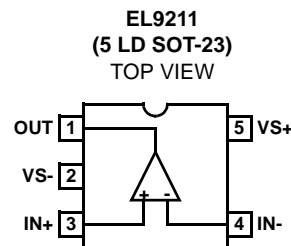

# EL9211, EL9212, EL9214

## Absolute Maximum Ratings (T<sub>A</sub> = +25°C)

Supply Voltage between V <sub>S+</sub> and V <sub>S-</sub>	+15V
Input Voltage	V <sub>S-</sub> - 0.5V, V <sub>S</sub> +0.5V
Maximum Continuous Output Current	100mA
Ambient Operating Temperature	-40°C to +85°C

## Thermal Information

Power Dissipation	See Curves
Maximum Die Temperature	+125°C
Storage Temperature	-65°C to +150°C
Pb-free reflow profile	see link below
	<a href="http://www.intersil.com/pbfree/Pb-FreeReflow.asp">http://www.intersil.com/pbfree/Pb-FreeReflow.asp</a>

**CAUTION:** Do not operate at or near the maximum ratings listed for extended periods of time. Exposure to such conditions may adversely impact product reliability and result in failures not covered by warranty.

**IMPORTANT NOTE:** All parameters having Min/Max specifications are guaranteed. Typ values are for information purposes only. Unless otherwise noted, all tests are at the specified temperature and are pulsed tests, therefore: T<sub>J</sub> = T<sub>C</sub> = T<sub>A</sub>

**Electrical Specifications** V<sub>S+</sub> = +6V, V<sub>S-</sub> = -6V, R<sub>L</sub> = 10kΩ, R<sub>F</sub> = 0Ω, C<sub>L</sub> = 10pF to 0V, Gain = -1, T<sub>A</sub> = +25°C, unless otherwise specified.

PARAMETER	DESCRIPTION	CONDITIONS	MIN (Note 2)	TYP	MAX (Note 2)	UNIT
<b>INPUT CHARACTERISTICS</b>						
V <sub>OS</sub>	Input Offset Voltage	V <sub>CM</sub> = 6V	-6	-1	+2	mV
TCV <sub>OS</sub>	Average Offset Voltage Drift	(Note 1)		10		μV/°C
I <sub>B</sub>	Input Bias Current	V <sub>CM</sub> = 6V	-1.4		-0.4	μA
R <sub>IN</sub>	Input Impedance			1		GΩ
C <sub>IN</sub>	Input Capacitance			1.35		pF
V <sub>REG</sub>	Load Regulation	V <sub>COM</sub> = 6V, -100mA < I <sub>L</sub> < 100mA	-20		+20	mV
CMIR	Common Mode Input Range		-0.5		+12.5	V
CMRR	Common Mode Rejection Ratio	For V <sub>IN</sub> from -0.5 to +12.5V	75	100		dB
A <sub>VOL</sub>	Open Loop Gain		55	70		dB
<b>OUTPUT CHARACTERISTICS</b>						
V <sub>OL</sub>	Output Swing Low	I <sub>L</sub> = -5mA		0.9	1.1	V
V <sub>OH</sub>	Output Swing High	I <sub>L</sub> = +5mA	10.7	10.94		V
I <sub>SC</sub>	Short Circuit Current			300		mA
<b>POWER SUPPLY PERFORMANCE</b>						
PSRR	Power Supply Rejection Ratio	V <sub>S</sub> from 4.5V to 10.5V	50	75		dB
I <sub>S</sub>	Total Supply Current	EL9211 (no load)		2.3	2.9	mA
		EL9212 (no load)		4.5	5	mA
		EL9214 (no load)		8.8	9.6	mA
<b>DYNAMIC PERFORMANCE</b>						
SR	Slew Rate (Note)	2V step, 20% to 80%	90	115		V/μs
t <sub>S</sub>	Settling to +0.1% (A <sub>V</sub> = -1)	(A <sub>V</sub> = -1), V <sub>O</sub> = 2V step		30		ns
BW	-3dB Bandwidth	R <sub>L</sub> = 10kΩ, C <sub>L</sub> = 10pF, A <sub>V</sub> = +1		130		MHz
		R <sub>L</sub> = 10kΩ, C <sub>L</sub> = 10pF, A <sub>V</sub> = -1		52		MHz
GBWP	Gain-Bandwidth Product	R <sub>L</sub> = 10kΩ, C <sub>L</sub> = 10pF		63		MHz
PM	Phase Margin	R <sub>L</sub> = 10kΩ, C <sub>L</sub> = 10pF		43		°

NOTE:

- Slew rate is measured on rising and falling edges.
- Parts are 100% tested at +25°C. Over-temperature limits established by characterization and are not production tested.

Typical Performance Curves

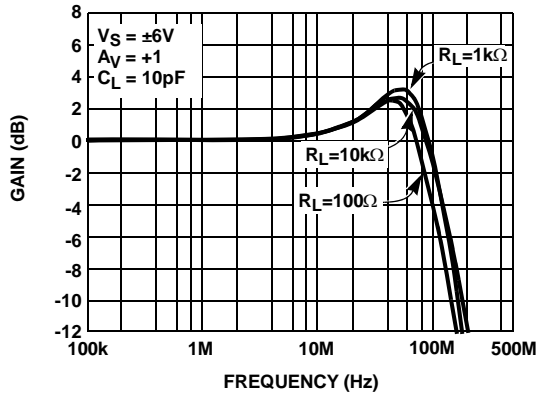

FIGURE 1. FREQUENCY RESPONSE FOR VARIOUS  $R_L$

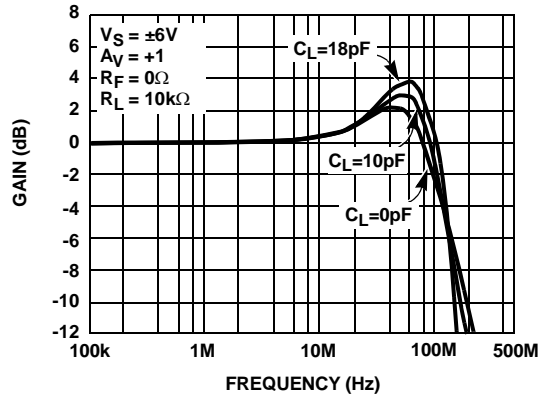

FIGURE 2. FREQUENCY RESPONSE FOR VARIOUS  $C_L$

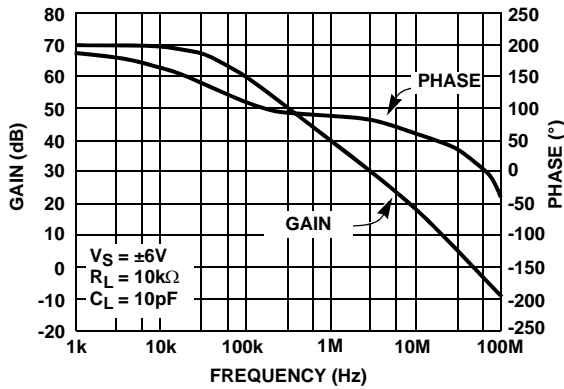

FIGURE 3. OPEN LOOP GAIN AND PHASE vs FREQUENCY

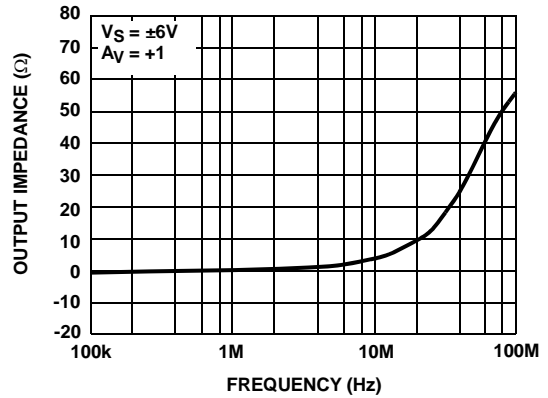

FIGURE 4. CLOSED LOOP OUTPUT IMPEDANCE vs FREQUENCY

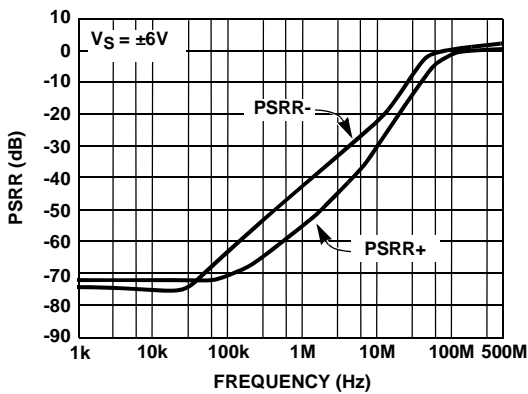

FIGURE 5. PSRR

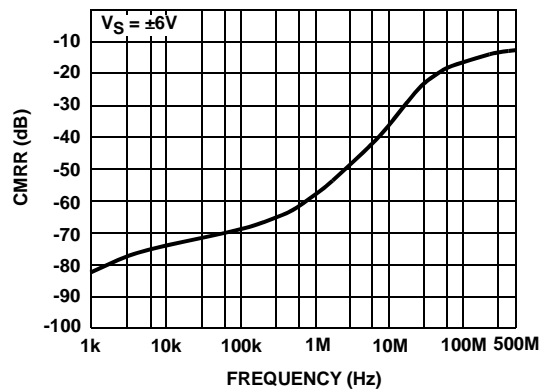

FIGURE 6. CMRR

Typical Performance Curves (Continued)

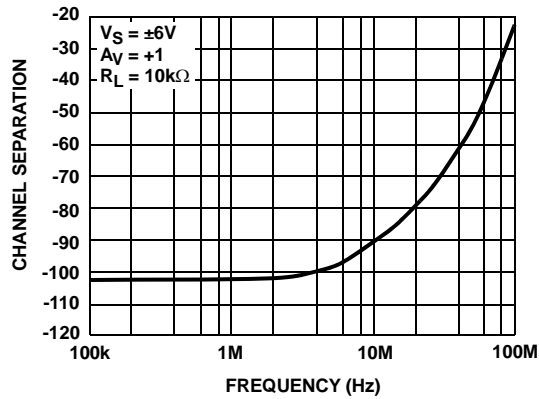

FIGURE 7. CHANNEL SEPARATION FOR EL9212/EL9214

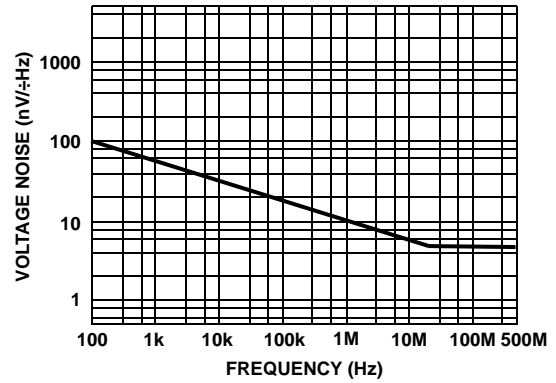

FIGURE 8. VOLTAGE NOISE vs FREQUENCY

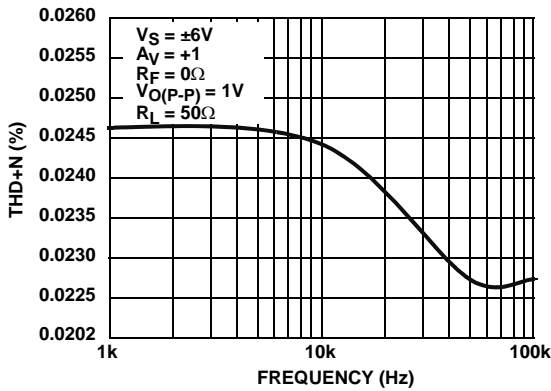

FIGURE 9. THD + NOISE vs FREQUENCY

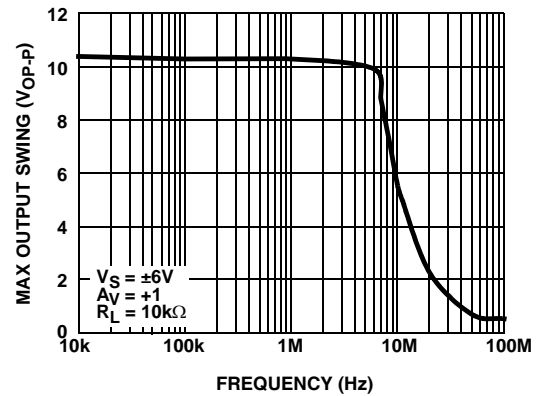

FIGURE 10. MAXIMUM OUTPUT SWING vs FREQUENCY

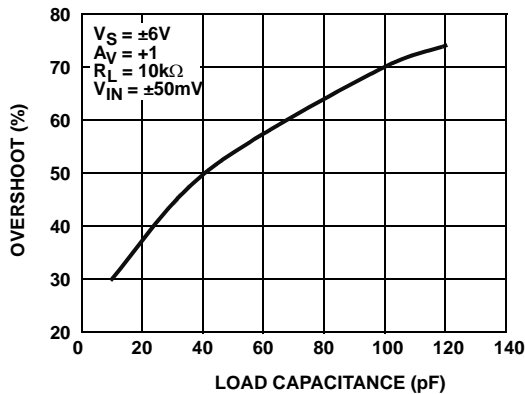

FIGURE 11. SMALL SIGNAL OVERSHOOT vs LOAD CAPACITANCE

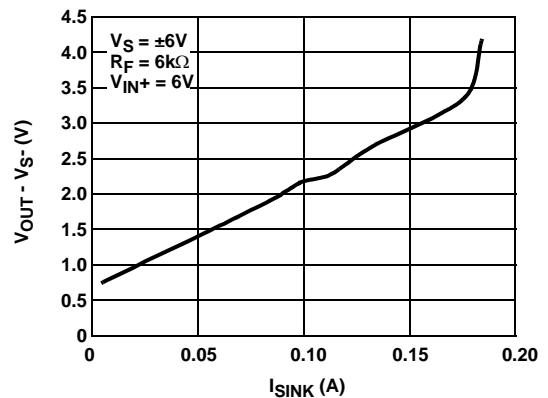

FIGURE 12.  $V_{OUT} - V_{S-}$  vs  $I_{SINK}$

Typical Performance Curves (Continued)

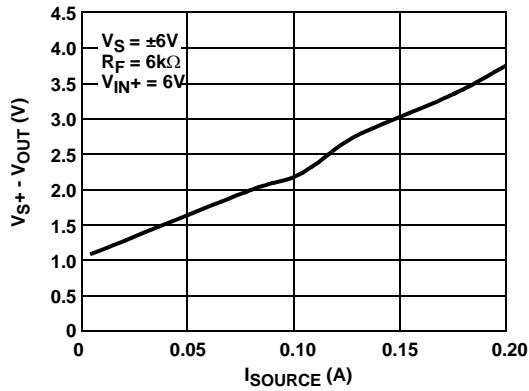

FIGURE 13.  $V_{S+} - V_{OUT}$  vs  $I_{SOURCE}$

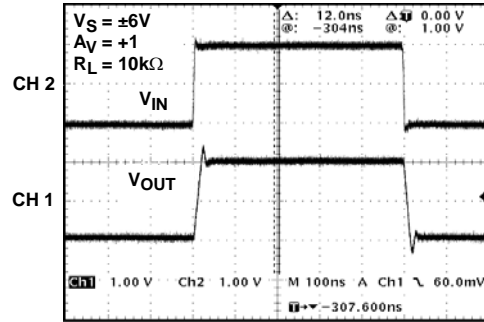

FIGURE 14. LARGE SIGNAL TRANSIENT RESPONSE

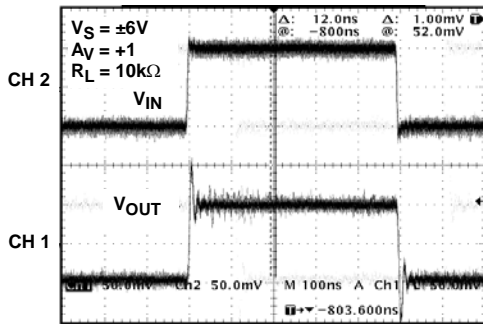

FIGURE 15. SMALL SIGNAL TRANSIENT RESPONSE

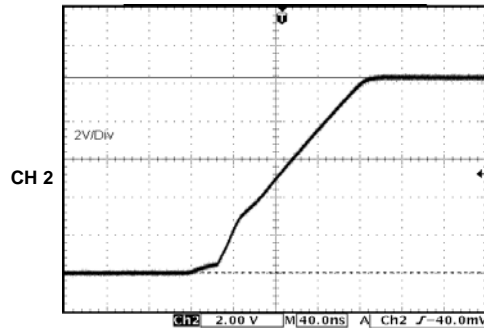

FIGURE 16. GOING INTO SATURATION POSITIVE EDGE

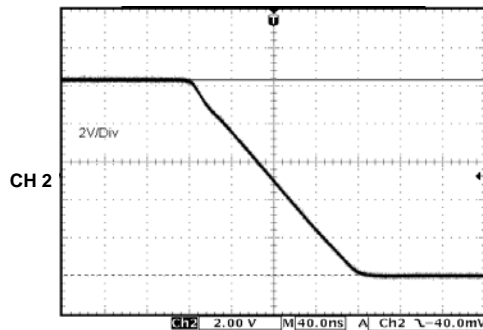

FIGURE 17. GOING INTO SATURATION NEGATIVE EDGE

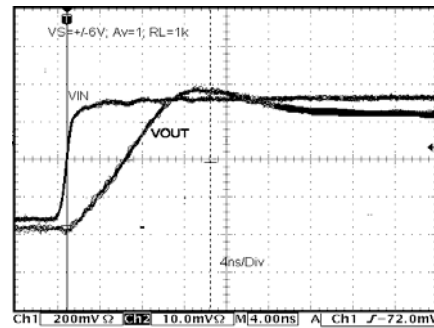

FIGURE 18. DELAY TIME

Typical Performance Curves (Continued)

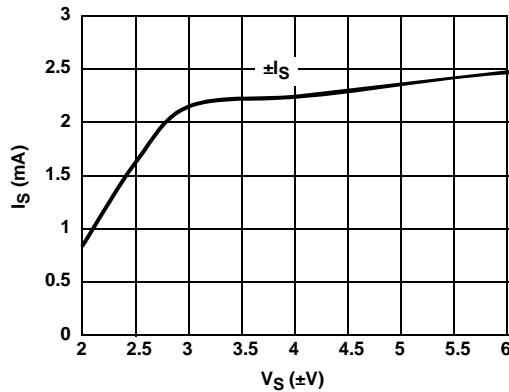

FIGURE 19. SUPPLY CURRENT (PER AMPLIFIER) vs SUPPLY VOLTAGE

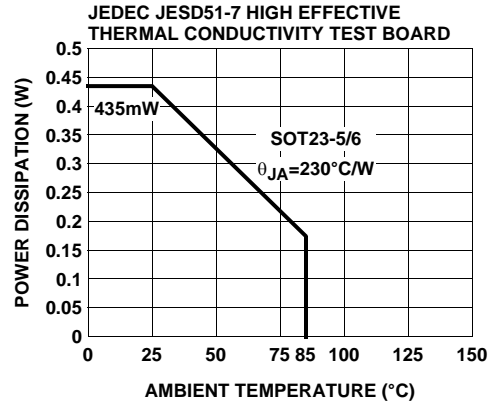

FIGURE 20. PACKAGE POWER DISSIPATION vs AMBIENT TEMPERATURE

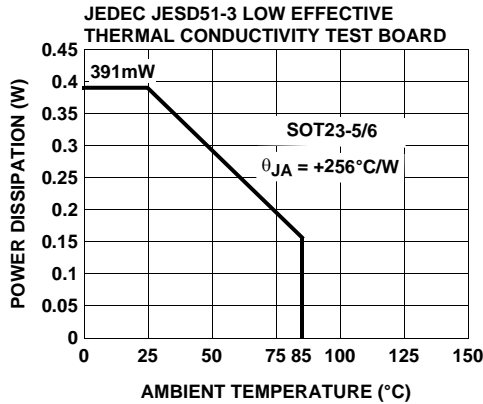

FIGURE 21. PACKAGE POWER DISSIPATION vs AMBIENT TEMPERATURE

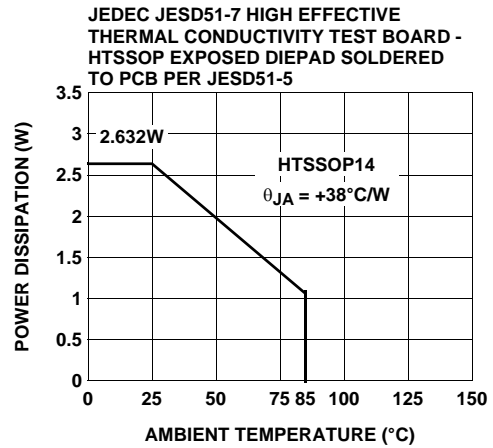

FIGURE 22. PACKAGE POWER DISSIPATION vs AMBIENT TEMPERATURE

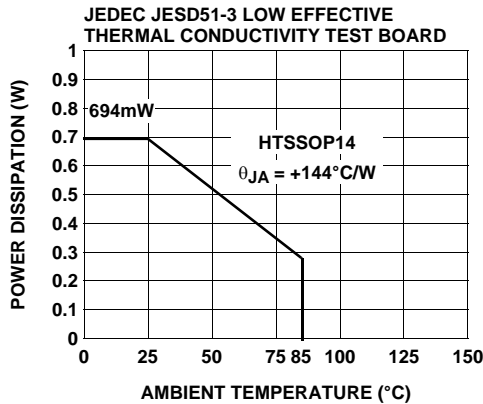
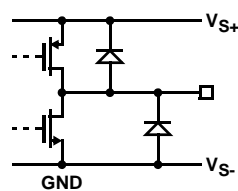
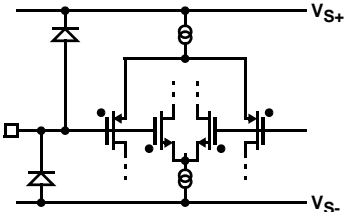

FIGURE 23. PACKAGE POWER DISSIPATION vs AMBIENT TEMPERATURE

Pin Descriptions

EL9211 (5 LD SOT-23)	EL9211 (8 LD HMSOP)	EL9212 (8 LD HMSOP)	EL9214 (14 LD HTSSOP)	PIN NAME	FUNCTION	EQUIVALENT CIRCUIT
1	6	1	1	VOUTA	Amplifier A output	 <p>CIRCUIT 1</p>
4	2	2	2	VINA-	Amplifier A inverting input	 <p>CIRCUIT 2</p>
3	3	3	3	VINA+	Amplifier A non-inverting input	(Reference Circuit 2)
5	7	8	4	VS+	Positive power supply	
		5	5	VINB+	Amplifier B non-inverting input	(Reference Circuit 2)
		6	6	VINB-	Amplifier B inverting input	(Reference Circuit 2)
		7	7	VOUTB	Amplifier B output	(Reference Circuit 1)
			8	VOUTC	Amplifier C output	(Reference Circuit 1)
			9	VINC-	Amplifier C inverting input	(Reference Circuit 2)
			10	VINC+	Amplifier C non-inverting input	(Reference Circuit 2)
2	4	4	11	VS-	Negative power supply	
			12	VIND+	Amplifier D non-inverting input	(Reference Circuit 2)
			13	VIND-	Amplifier D inverting input	(Reference Circuit 2)
			14	VOUTD	Amplifier D output	(Reference Circuit 1)
	1, 5, 8			NC	Not connected	

## Application Information

### Product Description

The EL9211, EL9212, and EL9214 voltage feedback amplifiers are fabricated using a high voltage CMOS process. They exhibit rail-to-rail input and output capability, are unity gain stable and have low power consumption (2.4mA per amplifier). These features make the EL9211, EL9212, and EL9214 ideal for a wide range of general-purpose applications. Connected in voltage follower mode and driving a load of 10K, the EL9211, EL9212, and EL9214 have a -3dB bandwidth of 130MHz while maintaining a 115V/ $\mu$ s slew rate. The EL9211 is a single amplifier, EL9212 is a dual amplifier, and EL9214 is a quad amplifier.

### Operating Voltage, Input, and Output

The EL9211, EL9212, and EL9214 are specified with a single nominal supply voltage from 5V to 13.5V or a split supply with its total range from 5V to 13.5V. Most EL9211, EL9212, and EL9214 specifications are stable over both the full supply range and operating temperatures of -40°C to +85°C. Parameter variations with operating voltage and/or temperature are shown in the typical performance curves.

### Short Circuit Current Limit

The EL9211, EL9212, and EL9214 will limit the short circuit current to 300mA if the output is directly shorted to the positive or negative supply. If an output is shorted indefinitely, the power dissipation could easily increase such that the device may be damaged. Maximum reliability is maintained if the output continuous current never exceeds  $\pm 65$ mA. This limit is set by the design of the internal metal interconnects.

### Output Phase Reversal

The EL9211, EL9212, and EL9214 are immune to phase reversal as long as the input voltage is limited from -VS -0.5V to +VS +0.5V. Although the device's output will not change phase, the input's over-voltage should be avoided. If an input voltage exceeds supply voltage by more than 0.6V, electrostatic protection diodes placed in the input stage of the device begin to conduct and over-voltage damage could occur.

### Unused Amplifiers

It is recommended that any unused amplifiers in a dual and quad package be configured as a unity gain follower. The inverting input should be directly connected to the output and the non-inverting input tied to the ground plane.

### Power Supply Bypassing and Printed Circuit Board Layout

The EL9211, EL9212, and EL9214 can provide gain at high frequency. As with any high-frequency device, good printed circuit board layout is necessary for optimum performance. Ground plane construction is highly recommended, lead lengths should be as short as possible and the power supply pins must be well bypassed to reduce the risk of oscillation. For normal single supply operation, where the -VS pin is connected to ground, a 0.1 $\mu$ F ceramic capacitor should be placed from +VS to pin and -VS to pin. A 4.7 $\mu$ F tantalum capacitor should then be connected in parallel, placed in the region of the amplifier. One 4.7 $\mu$ F capacitor may be used for multiple devices. This same capacitor combination should be placed at each supply pin to ground if split supplies are to be used.



SOT-23 Package Family

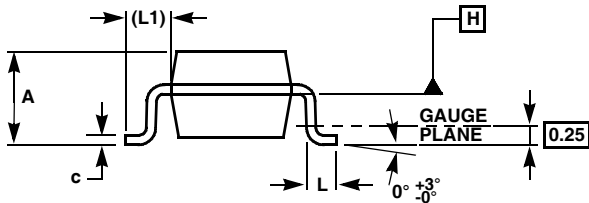
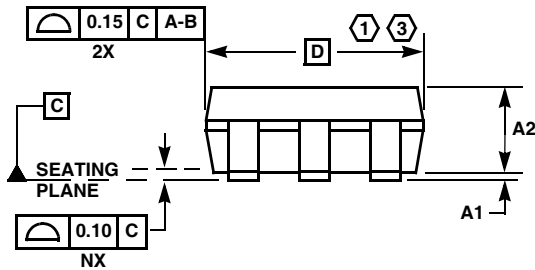
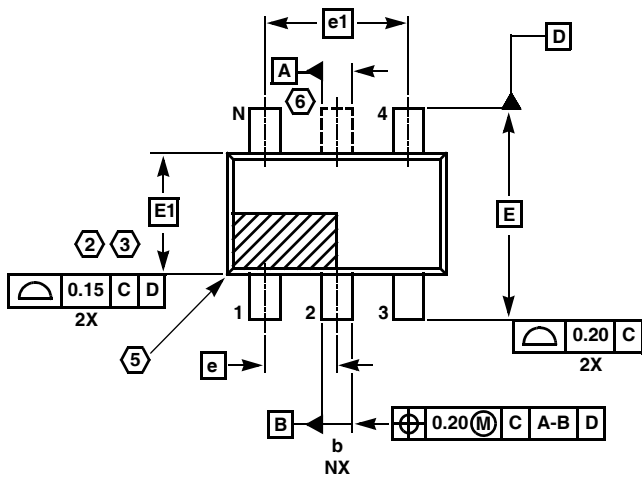

MDP0038

SOT-23 PACKAGE FAMILY

SYMBOL	MILLIMETERS		TOLERANCE
	SOT23-5	SOT23-6	
A	1.45	1.45	MAX
A1	0.10	0.10	±0.05
A2	1.14	1.14	±0.15
b	0.40	0.40	±0.05
c	0.14	0.14	±0.06
D	2.90	2.90	Basic
E	2.80	2.80	Basic
E1	1.60	1.60	Basic
e	0.95	0.95	Basic
e1	1.90	1.90	Basic
L	0.45	0.45	±0.10
L1	0.60	0.60	Reference
N	5	6	Reference

Rev. F 2/07

NOTES:

1. Plastic or metal protrusions of 0.25mm maximum per side are not included.
2. Plastic interlead protrusions of 0.25mm maximum per side are not included.
3. This dimension is measured at Datum Plane "H".
4. Dimensioning and tolerancing per ASME Y14.5M-1994.
5. Index area - Pin #1 I.D. will be located within the indicated zone (SOT23-6 only).
6. SOT23-5 version has no center lead (shown as a dashed line).

HTSSOP (Heat-Sink TSSOP) Family

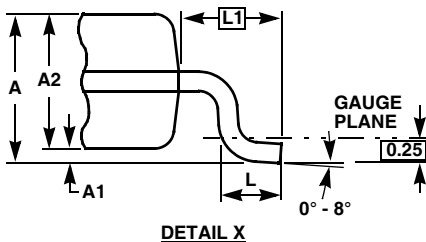
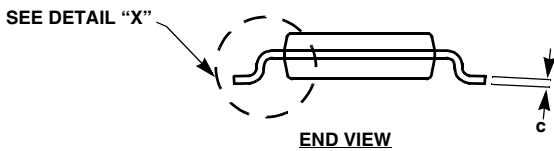
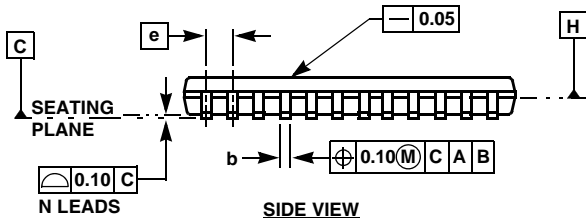
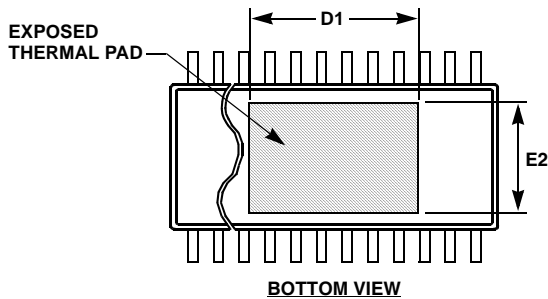
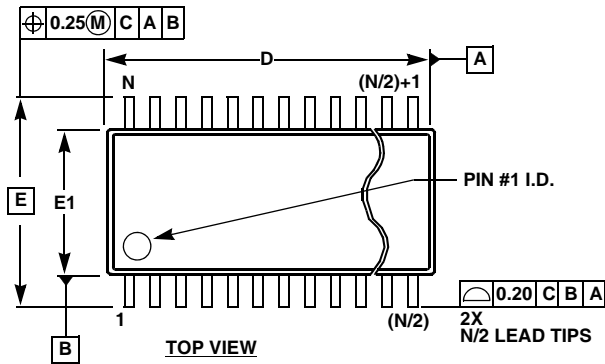

MDP0048

HTSSOP (HEAT-SINK TSSOP) FAMILY

SYMBOL	MILLIMETERS					TOLERANCE
	14 LD	20 LD	24 LD	28 LD	38 LD	
A	1.20	1.20	1.20	1.20	1.20	Max
A1	0.075	0.075	0.075	0.075	0.075	±0.075
A2	0.90	0.90	0.90	0.90	0.90	+0.15/-0.10
b	0.25	0.25	0.25	0.25	0.22	+0.05/-0.06
c	0.15	0.15	0.15	0.15	0.15	+0.05/-0.06
D	5.00	6.50	7.80	9.70	9.70	±0.10
D1	3.2	4.2	4.3	5.0	7.25	Reference
E	6.40	6.40	6.40	6.40	6.40	Basic
E1	4.40	4.40	4.40	4.40	4.40	±0.10
E2	3.0	3.0	3.0	3.0	3.0	Reference
e	0.65	0.65	0.65	0.65	0.50	Basic
L	0.60	0.60	0.60	0.60	0.60	±0.15
L1	1.00	1.00	1.00	1.00	1.00	Reference
N	14	20	24	28	38	Reference

Rev. 3 2/07

NOTES:

1. Dimension "D" does not include mold flash, protrusions or gate burrs. Mold flash, protrusions or gate burrs shall not exceed 0.15mm per side.
2. Dimension "E1" does not include interlead flash or protrusions. Interlead flash and protrusions shall not exceed 0.25mm per side.
3. Dimensions "D" and "E1" are measured at Datum Plane H.
4. Dimensioning and tolerancing per ASME Y14.5M-1994.

**HMSOP (Heat-Sink MSOP) Package Family**

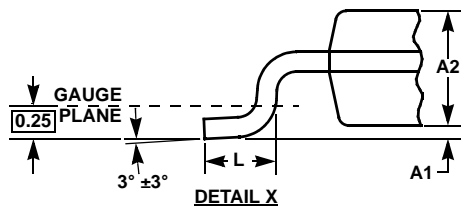
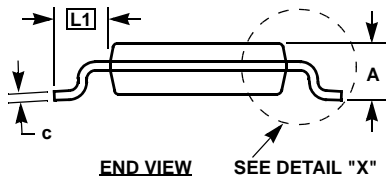
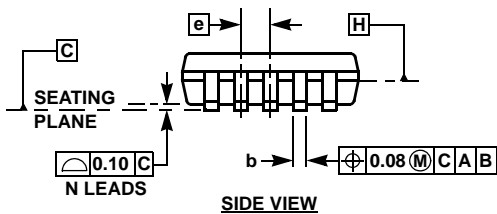
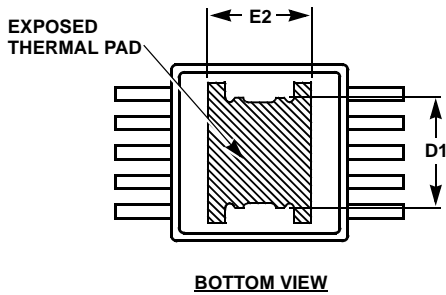
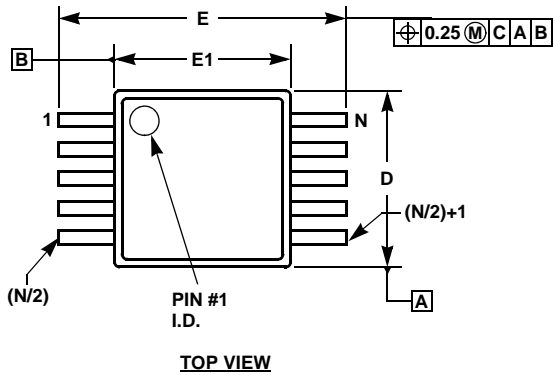

**MDP0050**

**HMSOP (HEAT-SINK MSOP) PACKAGE FAMILY**

SYMBOL	MILLIMETERS		TOLERANCE	NOTES
	HMSOP8	HMSOP10		
A	1.00	1.00	Max.	-
A1	0.075	0.075	+0.025/-0.050	-
A2	0.86	0.86	±0.09	-
b	0.30	0.20	+0.07/-0.08	-
c	0.15	0.15	±0.05	-
D	3.00	3.00	±0.10	1, 3
D1	1.85	1.85	Reference	-
E	4.90	4.90	±0.15	-
E1	3.00	3.00	±0.10	2, 3
E2	1.73	1.73	Reference	-
e	0.65	0.50	Basic	-
L	0.55	0.55	±0.15	-
L1	0.95	0.95	Basic	-
N	8	10	Reference	-

Rev. 1 2/07

**NOTES:**

1. Plastic or metal protrusions of 0.15mm maximum per side are not included.
2. Plastic interlead protrusions of 0.25mm maximum per side are not included.
3. Dimensions "D" and "E1" are measured at Datum Plane "H".
4. Dimensioning and tolerancing per ASME Y14.5M-1994.

All Intersil U.S. products are manufactured, assembled and tested utilizing ISO9000 quality systems. Intersil Corporation's quality certifications can be viewed at [www.intersil.com/design/quality](http://www.intersil.com/design/quality)

*Intersil products are sold by description only. Intersil Corporation reserves the right to make changes in circuit design, software and/or specifications at any time without notice. Accordingly, the reader is cautioned to verify that data sheets are current before placing orders. Information furnished by Intersil is believed to be accurate and reliable. However, no responsibility is assumed by Intersil or its subsidiaries for its use; nor for any infringements of patents or other rights of third parties which may result from its use. No license is granted by implication or otherwise under any patent or patent rights of Intersil or its subsidiaries.*

For information regarding Intersil Corporation and its products, see [www.intersil.com](http://www.intersil.com)